

**CLASS : XII**

**SESSION: 2023-24**

**CBSE SAMPLE QUESTION PAPER**

**SUBJECT: PHYSICS (THEORY)**

**Maximum Marks: 70**

**Time Allowed: 3 hours.**

**General Instructions:**

- (1) There are 33 questions in all. All questions are compulsory.
- (2) This question paper has five sections: Section A, Section B, Section C, Section D and Section E.
- (3) All the sections are compulsory.
- (4) **Section A** contains sixteen questions, twelve MCQ and four Assertion Reasoning based of 1 mark each, **Section B** contains five questions of two marks each, **Section C** contains seven questions of three marks each, **Section D** contains two case study based questions of four marks each and **Section E** contains three long answer questions of five marks each.
- (5) There is no overall choice. However, an internal choice has been provided in one question in Section B, one question in Section C, one question in each CBQ in Section D and all three questions in Section E. You have to attempt only one of the choices in such questions.
- (6) Use of calculators is not allowed.
- (7) You may use the following values of physical constants where ever necessary
  - i.  $c = 3 \times 10^8$  m/s
  - ii.  $m_e = 9.1 \times 10^{-31}$  kg
  - iii.  $e = 1.6 \times 10^{-19}$  C
  - iv.  $\mu_0 = 4\pi \times 10^{-7}$  TmA<sup>-1</sup>
  - v.  $h = 6.63 \times 10^{-34}$  Js
  - vi.  $\epsilon_0 = 8.854 \times 10^{-12}$  C<sup>2</sup>N<sup>-1</sup>m<sup>-2</sup>
  - vii. Avogadro's number =  $6.023 \times 10^{23}$  per gram mole

**SECTION-A**

1. Which of the following is not the property of an equipotential surface?
  - (a) They do not cross each other.
  - (b) The work done in carrying a charge from one point to another on an equipotential surface is zero.
  - (c) For a uniform electric field, they are concentric spheres.
  - (d) They can be imaginary spheres.
  
2. An electric dipole placed in an electric field of intensity  $2 \times 10^5$  N/C at an angle of  $30^\circ$  experiences a torque equal to 4 Nm. The charge on the dipole of dipole length 2 cm is
  - (a) 7  $\mu$ C
  - (b) 8 mC
  - (c) 2 mC
  - (d) 5 mC

3. A metallic plate exposed to white light emits electrons. For which of the following colours of light, the stopping potential will be maximum?  
 (a) Blue (b) Yellow (c) Red (d) Violet
4. When alpha particles are sent through a thin gold foil, most of them go straight through the foil, because  
 (a) alpha particles are positively charged  
 (b) the mass of an alpha particle is more than the mass of an electron  
 (c) most of the part of an atom is empty space  
 (d) alpha particles move with high velocity
5. An electron is moving along positive x-axis in a magnetic field which is parallel to the positive y-axis. In what direction will the magnetic force be acting on the electron?  
 (a) Along -x axis (b) Along -z axis  
 (c) Along +z axis (d) Along -y axis
6. The relative permeability of a substance X is slightly less than unity and that of substance Y is slightly more than unity, then  
 (a) X is paramagnetic and Y is ferromagnetic  
 (b) X is diamagnetic and Y is ferromagnetic  
 (c) X and Y both are paramagnetic  
 (d) X is diamagnetic and Y is paramagnetic
7. An ammeter of resistance 0.81 ohm reads up to 1 A. The value of the required shunt to increase the range to 10 A is  
 (a) 0.9 ohm (b) 0.09 ohm (c) 0.03 ohm (d) 0.3 ohm
8. An electron with angular momentum L moving around the nucleus has a magnetic moment given by  
 (a)  $e L / 2m$  (b)  $e L / 3m$  (c)  $e L / 4m$  (d)  $e L / m$
9. The large scale transmission of electrical energy over long distances is done with the use of transformers. The voltage output of the generator is stepped-up because of  
 (a) reduction of current (b) reduction of current and voltage both  
 (c) power loss is cut down (d) a and c both
10. The diagram below shows the electric field (**E**) and magnetic field (**B**) components of an electromagnetic wave at a certain time and location.

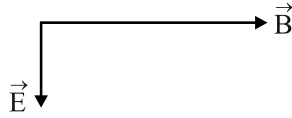

The direction of the propagation of the electromagnetic wave is

- (a) perpendicular to  $\mathbf{E}$  and  $\mathbf{B}$  and out of plane of the paper
- (b) perpendicular to  $\mathbf{E}$  and  $\mathbf{B}$  and into the plane of the paper
- (c) parallel and in the same direction as  $\mathbf{E}$
- (d) parallel and in the same direction as  $\mathbf{B}$

11. In a coil of resistance  $100 \Omega$  a current is induced by changing the magnetic flux through it. The variation of current with time is as shown in the figure. The magnitude of change in flux through coil is

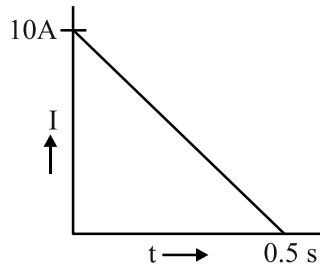

- (a) 200 Wb
- (b) 275 Wb
- (c) 225 Wb
- (d) 250 Wb

12. The energy of an electron in  $n^{\text{th}}$  orbit of hydrogen atom is  $E_n = -13.6/n^2 \text{ eV}$ . The negative sign of energy indicates that
- (a) electron is free to move.
  - (b) electron is bound to the nucleus.
  - (c) kinetic energy of electron is equal to potential energy of electron.
  - (d) atom is radiating energy.

For Questions 13 to 16, two statements are given –one labelled Assertion (A) and other labelled Reason (R). Select the correct answer to these questions from the options as given below.

- a) If both Assertion and Reason are true and Reason is correct explanation of Assertion.
- b) If both Assertion and Reason are true but Reason is not the correct explanation of Assertion.
- c) If Assertion is true but Reason is false.
- d) If both Assertion and Reason are false.

13. **Assertion (A):** For the radiation of a frequency greater than the threshold frequency, photoelectric current is proportional to the intensity of the radiation.  
**Reason (R):** Greater the number of energy quanta available, greater is the number of electrons absorbing the energy quanta and greater is number of electrons coming out of the metal.

14. **Assertion (A):** Putting p type semiconductor slab directly in physical contact with n type semiconductor slab cannot form the pn junction.  
**Reason (R):** The roughness at contact will be much more than inter atomic crystal spacing and continuous flow of charge carriers is not possible.

15. **Assertion (A)** : An electron has a higher potential energy when it is at a location associated with a negative value of potential and has a lower potential energy when at a location associated with a positive potential.  
**Reason (R)** : Electrons move from a region of higher potential to a region of lower potential.
16. **Assertion (A)** : Propagation of light through an optical fibre is due to total internal reflection taking place at the core-cladding interface.  
**Reason (R)**: Refractive index of the material of the cladding of the optical fibre is greater than that of the core.

### SECTION-B

17. (a) Name the device which utilizes unilateral action of a pn diode to convert ac into dc.  
(b) Draw the circuit diagram of full wave rectifier.
18. The wavelength  $\lambda$  of a photon and the de Broglie wavelength of an electron of mass  $m$  have the same value. Show that the energy of the photon is  $2\lambda mc/h$  times the kinetic energy of the electron, where  $c$  and  $h$  have their usual meanings.
19. A ray of monochromatic light passes through an equilateral glass prism in such a way that the angle of incidence is equal to the angle of emergence and each of these angles is  $3/4$  times the angle of the prism. Determine the angle of deviation and the refractive index of the glass prism.
20. A heating element using nichrome connected to a 230 V supply draws an initial current of 3.2 A which settles after a few seconds to a steady value of 2.8 A. What is the steady temperature of the heating element if the room temperature is  $27.0\text{ }^\circ\text{C}$  and the temperature coefficient of resistance of nichrome is  $1.70 \times 10^{-4}\text{ }^\circ\text{C}^{-1}$  ?
21. Show that the least possible distance between an object and its real image in a convex lens is  $4f$ , where  $f$  is the focal length of the lens.

### OR

In an astronomical telescope in normal adjustment a straight black line of length  $L$  is drawn on the objective lens. The eyepiece forms a real image of this line whose length is  $l$ . What is the angular magnification of the telescope?

### SECTION-C

22. A given coin has a mass of 3.0 g. Calculate the nuclear energy that would be required to separate all the neutrons and protons from each other. For simplicity assume that the coin is entirely made of  ${}_{29}^{63}\text{Cu}$  atoms (of mass 62.92960 u).  
Given  $m_p = 1.007825\text{u}$  and  $m_n = 1.008665\text{u}$ .

23. Charges  $(+q)$  and  $(-q)$  are placed at the points A and B respectively which are a distance  $2L$  apart. C is the midpoint between A and B. What is the work done in moving a charge  $+Q$  along the semicircle CRD.

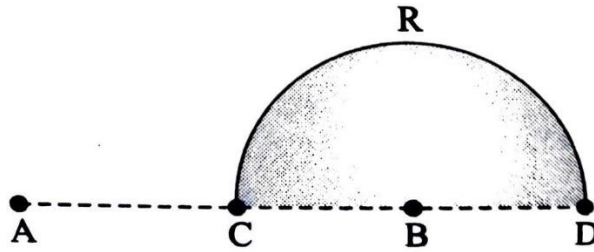

24. The total energy of an electron in the first excited state of the hydrogen atom is about  $-3.4$  eV.
- What is the kinetic energy of the electron in this state?
  - What is the potential energy of the electron in this state?
  - Which of the answers above would change if the choice of the zero of potential energy is changed?
25. A wire of uniform cross-section and resistance  $4$  ohm is bent in the shape of square ABCD. Point A is connected to a point P on DC by a wire AP of resistance  $1$  ohm. When a potential difference is applied between A and C, the points B and P are seen to be at the same potential. What is the resistance of the part DP?

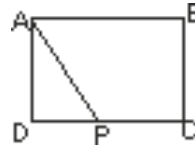

26. The given figure shows a long straight wire of a circular cross-section (radius  $a$ ) carrying steady current  $I$ . The current  $I$  is uniformly distributed across this cross-section. Calculate the magnetic field in the region  $r < a$  and  $r > a$ .

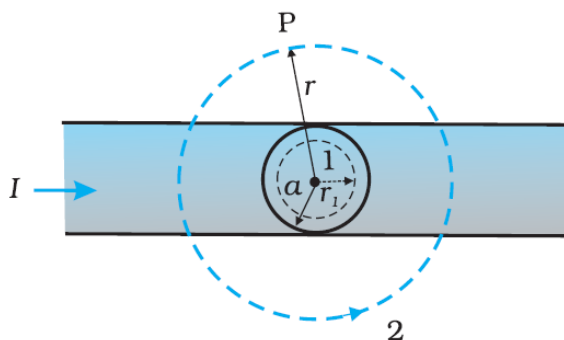

27. Identify the part of the electromagnetic spectrum which:
- produces heating effect,
  - is absorbed by the ozone layer in the atmosphere,
  - is used for studying crystal structure.

Write any one method of the production of each of the above radiations.

28. a. Define mutual inductance and write its SI unit.

- b. Two circular loops, one of small radius  $r$  and other of larger radius  $R$ , such that  $R \gg r$ , are placed coaxially with centres coinciding. Obtain the mutual inductance of the arrangement.

OR

Two long straight parallel current carrying conductors are kept 'a' distant apart in air. The direction of current in both the conductors is same. Find the magnitude of force per unit length and direction of the force between them. Hence define one ampere.

### SECTION-D

#### Case Study Based Questions

29. Read the following paragraph and answer the questions that follow.

A semiconductor diode is basically a pn junction with metallic contacts provided at the ends for the application of an external voltage. It is a two terminal device. When an external voltage is applied across a semiconductor diode such that p-side is connected to the positive terminal of the battery and n-side to the negative terminal, it is said to be forward biased. When an external voltage is applied across the diode such that n-side is positive and p-side is negative, it is said to be reverse biased. An ideal diode is one whose resistance in forward biasing is zero and the resistance is infinite in reverse biasing. When the diode is forward biased, it is found that beyond forward voltage called knee voltage, the conductivity is very high. When the biasing voltage is more than the knee voltage the potential barrier is overcome and the current increases rapidly with increase in forward voltage. When the diode is reverse biased, the reverse bias voltage produces a very small current about a few microamperes which almost remains constant with bias. This small current is reverse saturation current.

- i. In the given figure, a diode  $D$  is connected to an external resistance  $R = 100 \Omega$  and an emf of  $3.5 \text{ V}$ . If the barrier potential developed across the diode is  $0.5 \text{ V}$ , the current in the circuit will be:

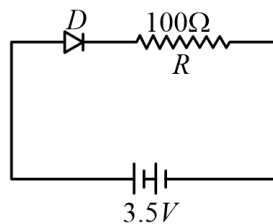

- (a) 40 mA                      (b) 20 mA                      (c) 35 mA                      (d) 30 mA

- ii. In which of the following figures, the pn diode is reverse biased?

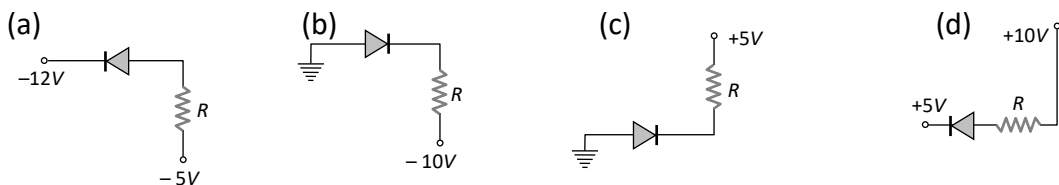

- iii. Based on the V-I characteristics of the diode, we can classify diode as  
 (a) bilateral device                      (b) ohmic device  
 (c) non-ohmic device                      (d) passive element

OR

Two identical  $PN$  junctions can be connected in series by three different methods as shown in the figure. If the potential difference in the junctions is the same, then the correct connections will be

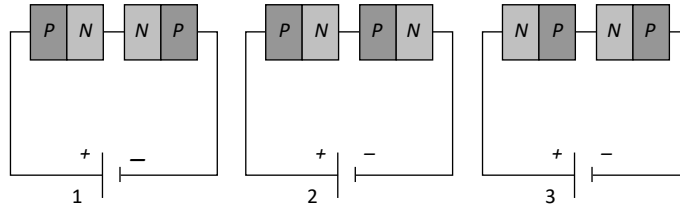

- (a) in the circuits (1) and (2)                      (b) in the circuits (2) and (3)  
 (c) in the circuits (1) and (3)                      (d) only in the circuit (1)

iv.

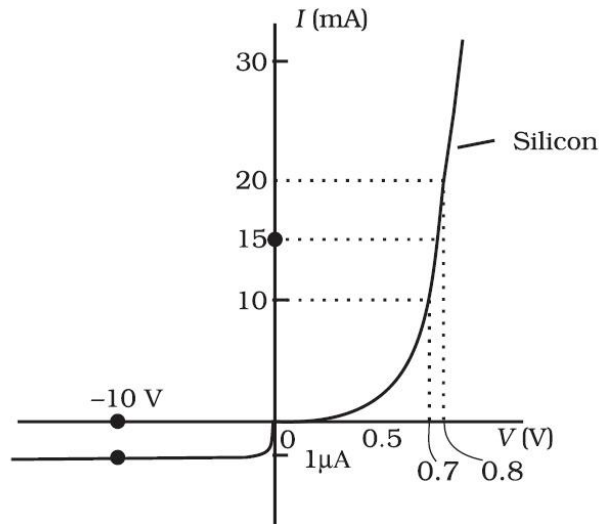

The  $V$ - $I$  characteristic of a diode is shown in the figure. The ratio of the resistance of the diode at  $I = 15 \text{ mA}$  to the resistance at  $V = -10 \text{ V}$  is

- (a) 100                      (b)  $10^6$                       (c) 10                      (d)  $10^{-6}$

30. Read the following paragraph and answer the questions that follow.

### Types of Lenses and their combination

A convex or converging lens is thicker at the centre than at the edges. It converges a beam of light on refraction through it. It has a real focus. Convex lens is of three types: Double convex lens, Plano convex lens and Concavo-convex lens.

Concave lens is thinner at the centre than at the edges. It diverges a beam of light on refraction through it. It has a virtual focus. Concave lenses are of three types: Double concave lens, Plano concave lens and Convexo-concave lens.

When two thin lenses of focal lengths  $f_1$  and  $f_2$  are placed in contact with each other along their common principal axis, then the two lens system is regarded as a single lens of focal length  $f$  and

$$\frac{1}{f} = \frac{1}{f_1} + \frac{1}{f_2}$$

If several thin lenses of focal length  $f_1, f_2, \dots, f_n$  are placed in contact, then the effective focal length of the combination is given by

$$\frac{1}{f} = \frac{1}{f_1} + \frac{1}{f_2} + \dots + \frac{1}{f_n}$$

and in terms of power, we can write

$$P = P_1 + P_2 + \dots + P_n$$

The value of focal length and power of a lens must be used with proper sign consideration.

- i. Two thin lenses are kept coaxially in contact with each other and the focal length of the combination is 80 cm. If the focal length of one lens is 20 cm, the focal length of the other would be  
(a) -26.7cm                      (b) 60cm                      (c) 80cm                      (d) 30cm
- ii. A spherical air bubble is embedded in a piece of glass. For a ray of light passing through the bubble, it behaves like a  
(a) converging lens  
(b) diverging lens  
(c) mirror  
(d) thin plane sheet of glass
- iii. Lens generally used in magnifying glass is  
(a) single concave lens  
(b) single convex lens  
(c) combination of convex lens of lower power and concave lens of lower focal length  
(d) Planoconcave lens
- iv. The magnification of an image by a convex lens is positive only when the object is placed  
(a) at its focus F  
(b) between F and 2F  
(c) at 2F  
(d) between F and optical centre

**OR**

A convex lens of 20 cm focal length forms a real image which is three times magnified. The distance of the object from the lens is

- (a) 13.33 cm                      (b) 14 cm                      (c) 26.66 cm                      (d) 25 cm



### SECTION-E

31. i. Draw a ray diagram for the formation of image of a point object by a thin double convex lens having radii of curvature  $R_1$  and  $R_2$ . Hence derive lens maker's formula.
- ii. A converging lens has a focal length of 10 cm in air. It is made of a material of refractive index 1.6. If it is immersed in a liquid of refractive index 1.3, find its new focal length.

OR

- i. Define a wavefront. How is it different from a ray?
- ii. Using Huygens's construction of secondary wavelets draw a diagram showing the passage of a plane wavefront from a denser to a rarer medium. Using it verify Snell's law.
- iii. In a double slit experiment using light of wavelength 600nm and the angular width of the fringe formed on a distant screen is  $0.1^\circ$ . Find the spacing between the two slits.
- iv. Write two differences between interference pattern and diffraction pattern.
32. i. Derive an expression for the capacitance of a parallel plate capacitor with air present between the two plates.
- ii. Obtain the equivalent capacitance of the network shown in figure. For a 300 V supply, determine the charge on each capacitor.

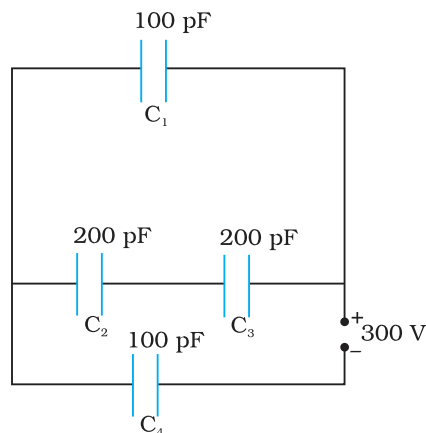

OR

- i. A dielectric slab of thickness 't' is kept between the plates of a parallel plate capacitor with plate separation 'd' ( $t < d$ ). Derive the expression for the capacitance of the capacitor.
- ii. A capacitor of capacity  $C_1$  is charged to the potential of  $V_0$ . On disconnecting with the battery, it is connected with an uncharged capacitor of capacity  $C_2$  as shown in the adjoining figure. Find the ratio of energies before and after the connection of switch  $S$ .

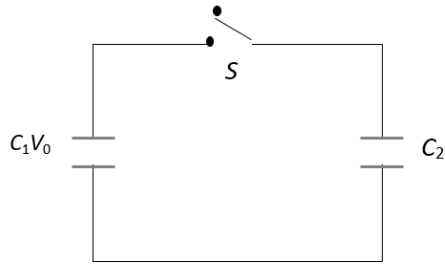

- 33.a.** Draw graphs showing the variations of inductive reactance and capacitive reactance with frequency of applied ac source.
- b.** Draw the phasor diagram for a series LRC circuit connected to an AC source.
- c.** When an alternating voltage of 220V is applied across a device X, a current of 0.25A flows which lags behind the applied voltage in phase by  $\pi/2$  radian. If the same voltage is applied across another device Y, the same current flows but now it is in phase with the applied voltage.
- (i) Name the devices X and Y.
- (ii) Calculate the current flowing in the circuit when the same voltage is applied across the series combination of X and Y.

**OR**

- a.** A series LCR circuit is connected to an ac source. Using the phasor diagram, derive the expression for the impedance of the circuit.
- b.** Plot a graph to show the variation of current with frequency of the ac source, explaining the nature of its variation for two different resistances  $R_1$  and  $R_2$  ( $R_1 < R_2$ ) at resonance.

**Class: XII Session 2023-24**  
**SUBJECT: PHYSICS(THEORY)**  
**MARKING SCHEME**  
**SECTION A**

- A1: c** **1M**
- A2: c**  $q = \tau / [(2a) E \sin \theta] = \frac{4}{2 \times 10^{-2} \times 2 \times 10^5 \sin 30^\circ}$  **1M**  
 $= 2 \times 10^{-3} \text{ C} = 2 \text{ mC}$
- A3: d** Higher the frequency, greater is the stopping potential **1M**
- A4: c** **1M**
- A5: b** **1M**
- A6: d** **1M**
- A7: b** **1M**

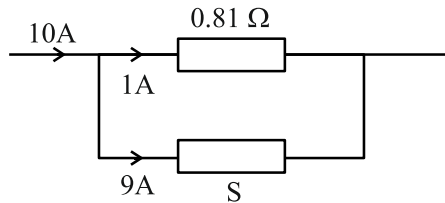

$$9 \times S = 1 \times 0.81$$

$$S = \frac{0.81}{9} = 0.09 \Omega$$

- A8: a** **1M**
- A9: d** **1M**
- A10: a** **1M**
- A11: d**  $e = \frac{\Delta \Phi}{\Delta t}, I = \frac{1}{R} \frac{\Delta \Phi}{\Delta t}$  **1M**
- $I \Delta t = \frac{\Delta \Phi}{R} = \text{Area under } I-t \text{ graph, } R = 100 \text{ ohm}$
- $\therefore \Delta \Phi = 100 \times \frac{1}{2} \times 10 \times 0.5 = 250 \text{ Wb.}$
- A12: b** **1M**
- A13: a** **1M**
- A14: a** **1M**
- A15: c** **1M**
- Q16: c** **1M**

**SECTION B**

- A17: (a) Rectifier** **1M**
- (b) Circuit diagram of full wave rectifier** **1M**

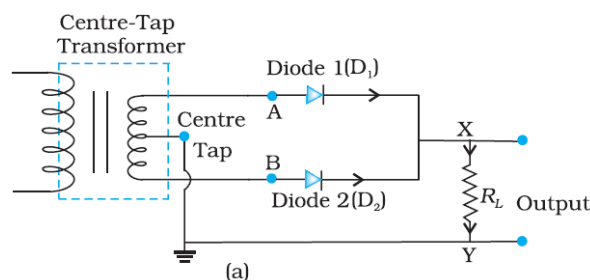

**A18:** As  $\lambda = h / mv$  ,  $v = h / m\lambda$  -----(i) 1/2M  
 Energy of photon  $E = hc / \lambda$  1/2M  
 & Kinetic energy of electron  $K = 1/2 mv^2 = 1/2 mh^2 / m^2 \lambda^2$  -----(ii) 1/2M  
 Simplifying equation i & ii we get  $E / K = 2\lambda mc / h$  1/2M

**A19:** Here angle of prism  $A = 60^\circ$ , angle of incidence  $i =$  angle of emergence  $e$  and under this condition angle of deviation is minimum

$$\therefore i = e = \frac{3}{4} A = \frac{3}{4} \times 60^\circ = 45^\circ \text{ and } i + e = A + D,$$

$$\text{hence } D_m = 2i - A = 2 \times 45^\circ - 60^\circ = 30^\circ \quad 1M$$

$\therefore$  Refractive index of glass prism

$$n = \frac{\sin\left(\frac{A + D_m}{2}\right)}{\sin\left(\frac{A}{2}\right)} = \frac{\sin\left(\frac{60^\circ + 30^\circ}{2}\right)}{\sin\left(\frac{60^\circ}{2}\right)} = \frac{\sin 45^\circ}{\sin 30^\circ} = \frac{1/\sqrt{2}}{1/2} = \sqrt{2}. \quad 1M$$

**A20:** Given:  $V = 230 \text{ V}$ ,  $I_0 = 3.2 \text{ A}$ ,  $I = 2.8 \text{ A}$ ,  $T_0 = 27^\circ \text{C}$ ,  $\alpha = 1.70 \times 10^{-4} \text{ }^\circ \text{C}^{-1}$ .

Using equation  $R = R_0 (1 + \alpha \Delta T)$  1/2 M

i.e  $V/I = \{V/I_0\} [1 + \alpha \Delta T]$  1/2 M

and solving  $\Delta T = 840$  , i.e.  $T = 840 + 27 = 867^\circ \text{C}$  1M

**A21:** Let  $d$  be the least distance between object and image for a real image formation.

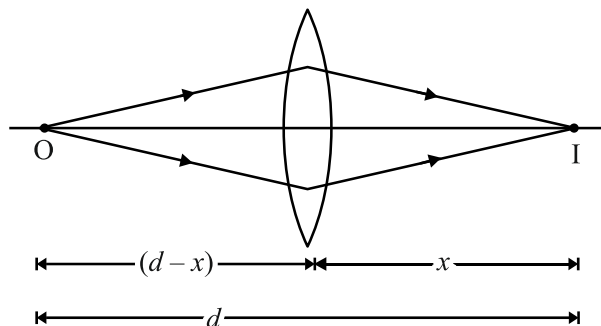

1/2 M

$$\frac{1}{f} = \frac{1}{v} - \frac{1}{u}, \quad \frac{1}{f} = \frac{1}{x} + \frac{1}{d-x} = \frac{d}{x(d-x)} \quad 1/2 M$$

$$fd = xd - x^2, \quad x^2 - dx + fd = 0, \quad x = \frac{d \pm \sqrt{d^2 - 4fd}}{2} \quad 1/2 M$$

$$\text{For real roots of } x, \quad d^2 - 4fd \geq 0 \quad 1/2 M$$

$$d \geq 4f.$$

**OR**

Let  $f_o$  and  $f_e$  be the focal length of the objective and eyepiece respectively.

For normal adjustment the distance from objective to eyepiece is  $f_o + f_e$ .

Taking the line on the objective as object and eyepiece as lens

$$u = -(f_o + f_e) \text{ and } f = f_e$$

$$\frac{1}{v} - \frac{1}{[-\{f_o + f_e\}]} = \frac{1}{f_e} \Rightarrow v = \left( \frac{f_o + f_e}{f_o} \right) f_e \quad 1M$$

Linear magnification (eyepiece) =  $\frac{v}{u} = \frac{\text{Image size}}{\text{Object size}} = \frac{f_e}{f_o} = \frac{l}{L}$  ½ M

∴ Angular magnification of telescope

$M = \frac{f_o}{f_e} = \frac{L}{l}$  ½ M

**SECTION C**

**A22:** Number of atoms in 3 gram of Cu coin =  $(6.023 \times 10^{23} \times 3) / 63 = 2.86 \times 10^{22}$  ½ M  
 Each atom has 29 Protons & 34 Neutrons

Thus Mass defect  $\Delta m = 29 \times 1.00783 + 34 \times 1.00867 - 62.92960 \text{ u} = 0.59225 \text{ u}$  1M

Nuclear energy required for one atom =  $0.59225 \times 931.5 \text{ MeV}$  ½ M

Nuclear energy required for 3 gram of Cu =  $0.59225 \times 931.5 \times 2.86 \times 10^{22} \text{ MeV}$   
 $= 1.58 \times 10^{25} \text{ MeV}$  1M

**A23:**

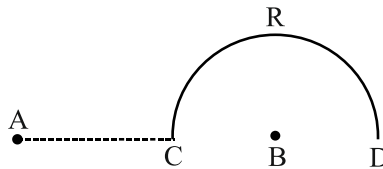

$V_C = 0,$  1M

$V_D = \frac{1}{4\pi\epsilon_0} \left[ \frac{q}{3L} - \frac{q}{L} \right] = \frac{-q}{6\pi\epsilon_0 L}$  1M

$W = Q [V_D - V_C] = \frac{-Qq}{6\pi\epsilon_0 L}$  1M

**A24:** formula  $K = -E, U = -2K$  1M

(a)  $K = 3.4 \text{ eV}$  & (b)  $U = -6.8 \text{ eV}$  1M

(c) The kinetic energy of the electron will not change. The value of potential energy and consequently, the value of total energy of the electron will change. 1M

**A25:**

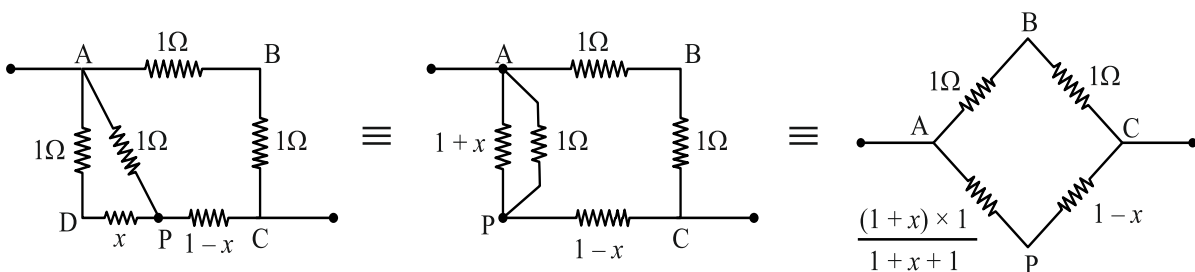

**1.5M**

As the points B and P are at the same potential,  $\frac{1}{1} = \frac{(1+x)}{(2+x)(1-x)} \Rightarrow x = (\sqrt{2} - 1) \text{ ohm}$  1.5M

**A26:**

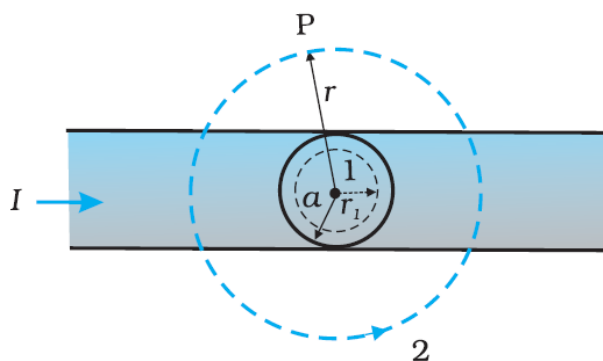

- (a) Consider the case  $r > a$ . The Amperian loop, labelled 2, is a circle concentric with the cross-section. For this loop,  $L = 2\pi r$

Using Ampere circuital Law, we can write,

$$B(2\pi r) = \mu_0 I, \quad B = \frac{\mu_0 I}{2\pi r}, \quad B \propto \frac{1}{r} \quad (r > a) \quad \mathbf{1.5 M}$$

- (b) Consider the case  $r < a$ . The Amperian loop is a circle labelled 1. For this loop, taking the radius of the circle to be  $r$ ,  $L = 2\pi r$

Now the current enclosed  $I_e$  is not  $I$ , but is less than this value. Since the current distribution is uniform, the current enclosed is,

$$I_e = I \left( \frac{\pi r^2}{\pi a^2} \right) = \frac{I r^2}{a^2} \quad \text{Using Ampere's law, } B(2\pi r) = \mu_0 \frac{I r^2}{a^2}$$

$$B = \left( \frac{\mu_0 I}{2\pi a^2} \right) r \quad B \propto r \quad (r < a) \quad \mathbf{1.5 M}$$

- A27:** (a) Infrared (b) Ultraviolet (c) X rays  $\frac{1}{2} + \frac{1}{2} + \frac{1}{2} M$   
 Any one method of the production of each one  $\frac{1}{2} + \frac{1}{2} + \frac{1}{2} M$

- A28 (a) :** Definition and S.I. Unit.  $\frac{1}{2} + \frac{1}{2} M$

(b)

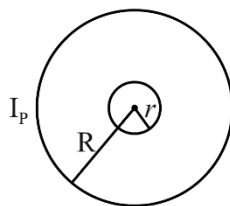

Let a current  $I_p$  flow through the circular loop of radius  $R$ . The magnetic induction at the centre of the loop is

$$B_p = \frac{\mu_0 I_p}{2R} \quad \mathbf{\frac{1}{2} M}$$

As,  $r \ll R$ , the magnetic induction  $B_p$  may be considered to be constant over the entire cross sectional area of inner loop of radius  $r$ . Hence magnetic flux linked with the smaller loop will be

$$\Phi_S = B_p A_S = \frac{\mu_0 I_p}{2R} \pi r^2 \quad \mathbf{\frac{1}{2} M}$$

Also,  $\Phi_S = M I_p \quad \mathbf{\frac{1}{2} M}$

$$\therefore M = \frac{\Phi_S}{I_p} = \frac{\mu_0 \pi r^2}{2R} \quad \frac{1}{2} M$$

OR

The magnetic induction  $B_1$  set up by the current  $I_1$  flowing in first conductor at a point somewhere in the middle of second conductor is

$$B_1 = \frac{\mu_0 I_1}{2\pi a} \quad \dots(1) \quad \frac{1}{2} M$$

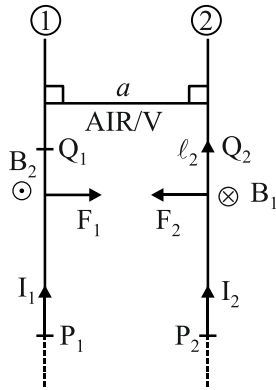

The magnetic force acting on the portion  $P_2Q_2$  of length  $\ell_2$  of second conductor is

$$F_2 = I_2 \ell_2 B_1 \sin 90^\circ \quad \dots(2)$$

From equation (1) and (2),

$$F_2 = \frac{\mu_0 I_1 I_2 \ell_2}{2\pi a}, \text{ towards first conductor} \quad \frac{1}{2} M$$

$$\frac{F_2}{\ell_2} = \frac{\mu_0 I_1 I_2}{2\pi a} \quad \dots(3)$$

The magnetic induction  $B_2$  set up by the current  $I_2$  flowing in second conductor at a point somewhere in the middle of first conductor is

$$B_2 = \frac{\mu_0 I_2}{2\pi a} \quad \dots(4) \quad \frac{1}{2} M$$

The magnetic force acting on the portion  $P_1Q_1$  of length  $\ell_1$  of first conductor is

$$F_1 = I_1 \ell_1 B_2 \sin 90^\circ \quad \dots(5)$$

From equation (3) and (5)

$$F_1 = \frac{\mu_0 I_1 I_2 \ell_1}{2\pi a}, \text{ towards second conductor} \quad \frac{1}{2} M$$

$$\frac{F_1}{\ell_1} = \frac{\mu_0 I_1 I_2}{2\pi a} \quad \dots(6)$$

The standard definition of 1A

If  $I_1 = I_2 = 1A$

$\ell_1 = \ell_2 = 1m$

$$a = 1m \text{ in V/A then } \frac{F_1}{\ell_1} = \frac{F_2}{\ell_2} = \frac{\mu_0 \times 1 \times 1}{2\pi \times 1} = 2 \times 10^{-7} \text{ N/m}$$

$\therefore$  One ampere is that electric current which when flows in each one of the two infinitely long straight parallel conductors placed 1m apart in vacuum causes each one of them to experience a force of  $2 \times 10^{-7} \text{ N/m}$ .

1M

## SECTION D

A29 (i) d (ii) c (iii) c OR b (iv) d

A30: (i) a (ii) b (iii) b (iv) d OR c

## SECTION E

A31: i. DIAGRAM/S : 1M

DERIVATION : 2M

NUMERICAL : 2 M

Lens maker's Formula

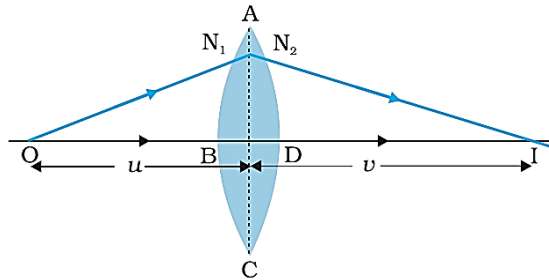

When a ray refracts from a lens (double convex), in above figure, then its image formation can be seen in term of two steps :

**Step 1:** The first refracting surface forms the image  $I_1$  of the object O

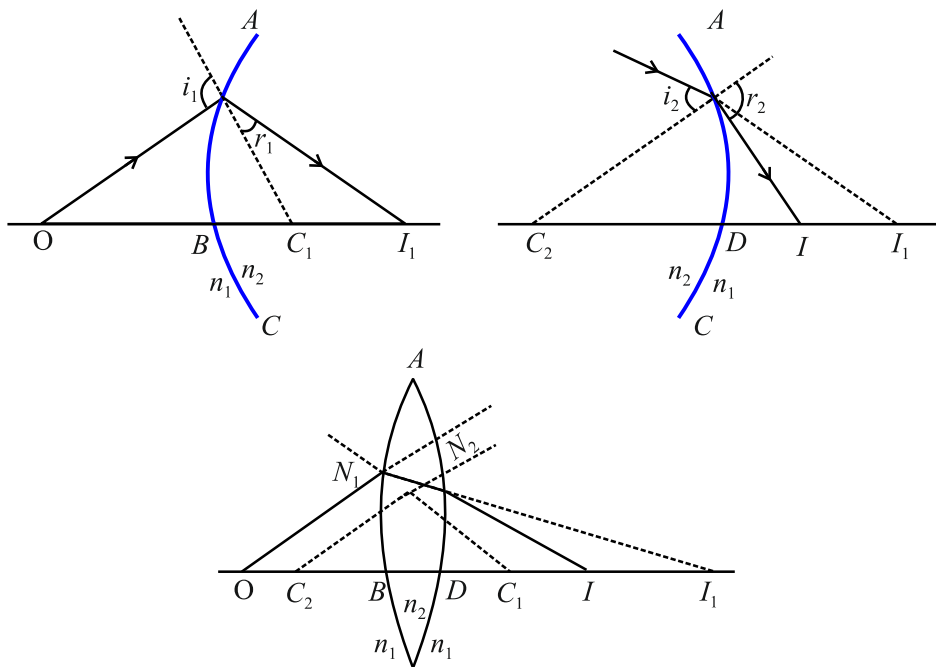

**Step 2:** The image of object O for first surface acts like a virtual object for the second surface. Now for the first surface ABC, ray will move from rarer to denser medium, then

$$\frac{n_2}{BI_1} + \frac{n_1}{OB} = \frac{n_2 - n_1}{BC_1} \quad \dots(i) \quad \frac{1}{2} \text{ M}$$

Similarly for the second interface, ADC we can write.

$$\frac{n_1}{DI} - \frac{n_2}{DI_1} = \frac{n_2 - n_1}{DC_2} \quad \dots(ii) \quad \frac{1}{2} \text{ M}$$

$DI_1$  is negative as distance is measured against the direction of incident light.

Adding equation (1) and equation (2), we get

$$\frac{n_2}{BI_1} + \frac{n_1}{OB} + \frac{n_1}{DI} - \frac{n_2}{DI_1} = \frac{n_2 - n_1}{BC_1} + \frac{n_2 - n_1}{DC_2}$$

or 
$$\frac{n_1}{DI} + \frac{n_1}{OB} = (n_2 - n_1) \left( \frac{1}{BC_1} + \frac{1}{DC_2} \right) \quad \dots(iii) \quad (\because \text{for thin lens } BI_1 = DI_1)$$



Now, if we assume the object to be at infinity *i.e.*  $OB \rightarrow \infty$ , then its image will form at focus  $F$  (with focal length  $f$ ), *i.e.* ½ M

$DI = f$ , thus equation (iii) can be rewritten as

$$\frac{n_1}{f} + \frac{n_1}{\infty} = (n_2 - n_1) \left( \frac{1}{BC_1} + \frac{1}{DC_2} \right)$$

or  $\frac{n_1}{f} = (n_2 - n_1) \left( \frac{1}{BC_1} + \frac{1}{DC_2} \right)$  ... (iv)

Now according to the sign conventions

$$BC_1 = +R_1 \text{ and } DC_2 = -R_2 \quad \dots (v) \quad \text{½ M}$$

Substituting equation (v) in equation (iv), we get

$$\frac{n_1}{f} = (n_2 - n_1) \left( \frac{1}{R_1} - \frac{1}{R_2} \right)$$

$$\frac{1}{f} = \left( \frac{n_2}{n_1} - 1 \right) \left( \frac{1}{R_1} - \frac{1}{R_2} \right)$$

$$\frac{1}{f} = (n_{21} - 1) \left( \frac{1}{R_1} - \frac{1}{R_2} \right)$$

(ii)  $\frac{1}{f_a} = (1.6 - 1) \left( \frac{1}{R_1} - \frac{1}{R_2} \right)$  ... (1) 1M

$\frac{1}{f_\ell} = \left[ \frac{1.6}{1.3} - 1 \right] \left( \frac{1}{R_1} - \frac{1}{R_2} \right)$  .... (2) 1M

From equation (1) and (2)

$$\frac{f_\ell}{f_a} = \left[ \frac{0.6}{0.3} \times 1.3 \right] \Rightarrow f_\ell = 2.6 \times 10 \text{ cm} \Rightarrow f_\ell = 26 \text{ cm}$$

**OR**

(i) A wavefront is defined as a surface of constant phase.

(a) The ray indicates the direction of propagation of wave while the wavefront is the surface of constant phase.

(b) The ray at each point of a wavefront is normal to the wavefront at that point.

1M

(ii) AB: Incident Plane Wave Front & CE is Refracted Wave front . 2M

$$\sin i = BC/AC \quad \& \quad \sin r = AE / AC$$

$$\sin i / \sin r = BC / AE = v_1 / v_2 = \text{constant}$$

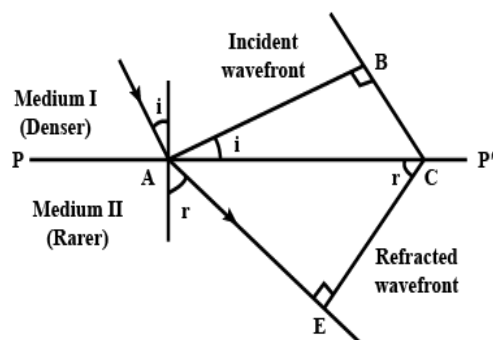

(iii)  $\theta = \lambda / a$  i.e.  $a = \frac{\lambda}{\theta} = \frac{6 \times 10^{-7}}{0.1 \times \frac{\pi}{180}} = 3.4 \times 10^{-4} \text{ m}$  **1M**

(iv) Two differences between interference pattern and diffraction pattern **1M**

**A32:** (i) Derivation of the expression for the capacitance **2M**

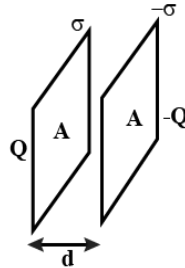

Let the two plates be kept parallel to each other separated by a distance  $d$  and cross-sectional area of each plate is  $A$ . Electric field by a single thin plate  $E = \sigma / 2\epsilon_0$

Total electric field between the plates  $E = \sigma / \epsilon_0 = Q / A \epsilon_0$

Potential difference between the plates  $V = Ed = [Q / A \epsilon_0] d$ .

Capacitance  $C = Q / V = A\epsilon_0 / d$

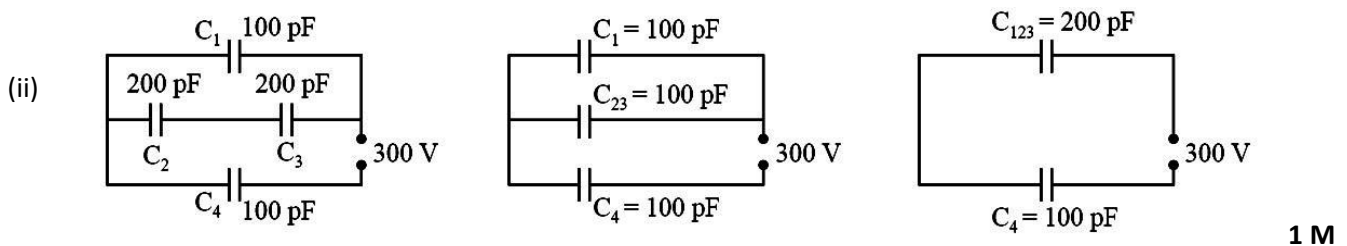

The equivalent capacitance  $= \frac{200}{3} \text{ pF}$

charge on  $C_4 = \frac{200}{3} \times 10^{-12} \times 300 = 2 \times 10^{-8} \text{ C}$ , **½ M**

potential difference across  $C_4 = \frac{200 \times 10^{-12} \times 300}{3 \times 100 \times 10^{-12}} = 200 \text{ V}$

potential difference across  $C_1 = 300 - 200 = 100 \text{ V}$

charge on  $C_1 = 100 \times 10^{-12} \times 100 = 1 \times 10^{-8} \text{ C}$  **½ M**

potential difference across  $C_2$  and  $C_3$  series combination  $= 100 \text{ V}$

potential difference across  $C_2$  and  $C_3$  each  $= 50 \text{ V}$

charge on  $C_2$  and  $C_3$  each  $= 200 \times 10^{-12} \times 50 = 1 \times 10^{-8} \text{ C}$  **½+½ M**

**OR**

(i) Derivation of the expression for capacitance with dielectric slab ( $t < d$ ) **3M**

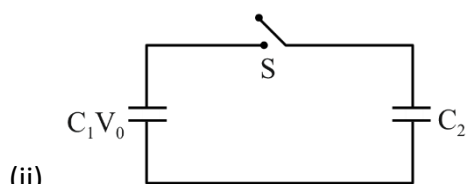

Before the connection of switch  $S$ ,

$$\text{Initial energy } U_i = \frac{1}{2}C_1V_0^2 + \frac{1}{2}C_2V_0^2 = \frac{1}{2}(C_1+C_2)V_0^2$$

½ M

After the connection of switch S

$$\text{common potential } V = \frac{C_1V_1 + C_2V_2}{C_1 + C_2} = \frac{C_1V_0}{C_1 + C_2}$$

½ M

$$\text{Final energy } = U_f = \frac{1}{2}(C_1 + C_2) \frac{(C_1V_0)^2}{(C_1 + C_2)^2} = \frac{1}{2} \frac{C_1^2V_0^2}{(C_1 + C_2)}$$

½ M

$$U_f : U_i = C_1 / (C_1 + C_2)$$

½ M

**A33:**

(a)

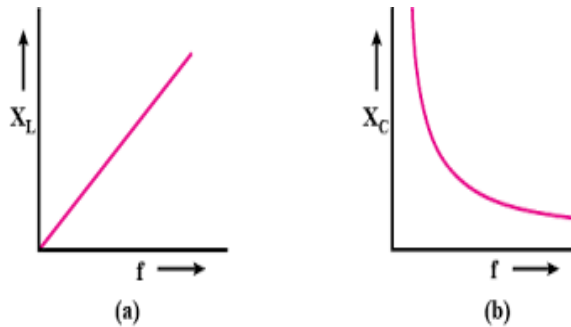

½ + ½ M

(b)

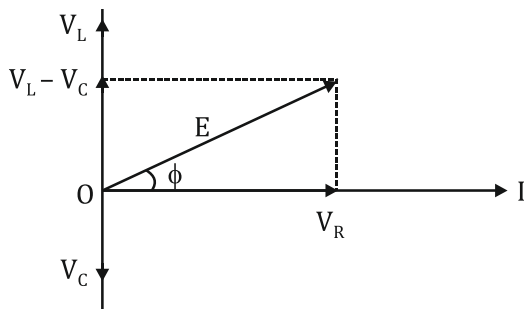

1M

(c)(i) In device X, Current lags behind the voltage by  $\pi/2$ , X is an inductor

In device Y, Current in phase with the applied voltage, Y is resistor

½ + ½ M

(ii) We are given that

$$0.25 = 220/X_L, X_L = 880\Omega, \text{ Also } 0.25 = 220/R, R = 880\Omega$$

1M

For the series combination of X and Y,

$$\text{Equivalent impedance } Z = 880\sqrt{2}\Omega, I = 0.177\text{ A}$$

1M

**OR**

a.

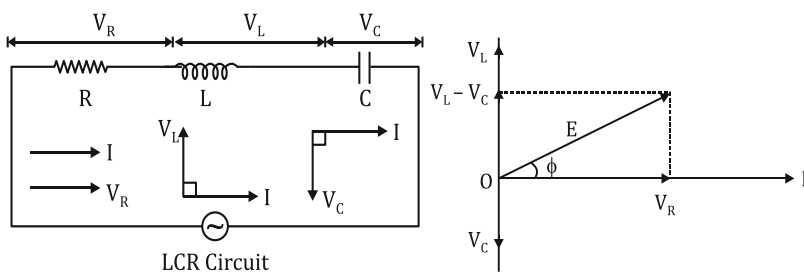

1M

$E = E_0 \sin \omega t$  is applied to a series LCR circuit. Since all three of them are connected in series the current through them is same. But the voltage across each element has a different phase relation with current.

The potential difference  $V_L$ ,  $V_C$  and  $V_R$  across L, C and R at any instant is given by

$V_L = IX_L$ ,  $V_C = IX_C$  and  $V_R = IR$ , where I is the current at that instant.

$V_R$  is in phase with I.  $V_L$  leads I by  $90^\circ$  and  $V_C$  lags behind I by  $90^\circ$  so the phasor diagram will be as shown

Assuming  $V_L > V_C$ , the applied emf E which is equal to resultant of potential drop across R, L & C is given as

$$E^2 = I^2 [ R^2 + (X_L - X_C)^2 ]$$

Or  $I = \frac{E}{\sqrt{[R^2 + (X_L - X_C)^2]}} = \frac{E}{Z}$ , where Z is Impedance. **3M**

Emf leads current by a phase angle  $\phi$  as  $\tan \phi = \frac{V_L - V_C}{R} = \frac{X_L - X_C}{R}$

b. The curve (i) is for  $R_1$  and the curve (ii) is for  $R_2$  **1M**

